



**PEINEMANN**

RENTAL - SALES - SERVICES

**TLX**

PEINEMANN EQUIPMENT 2018

**BUNDLE CLEANING**

# TLX

SINGLE | DUAL | TRIPLE LANCE



THE LIGHTEST, STRONGEST, MOST VERSATILE FEEDER IN THE INDUSTRY...30% LIGHTER AND 100% STRONGER!

TLX - DUAL LANCE - TRIPLE LANCE - PIPE CLEANING



# TLX | FEATURES

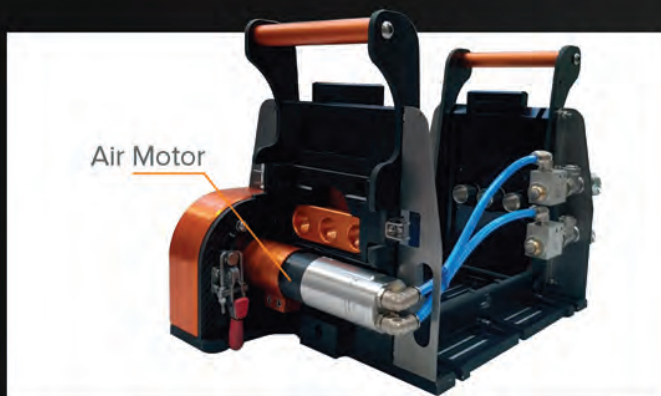

## FRONT MOUNTED AIR MOTOR NEW

Front mounted internally located airmotor, making the tool more compact, reducing the overall footprint.

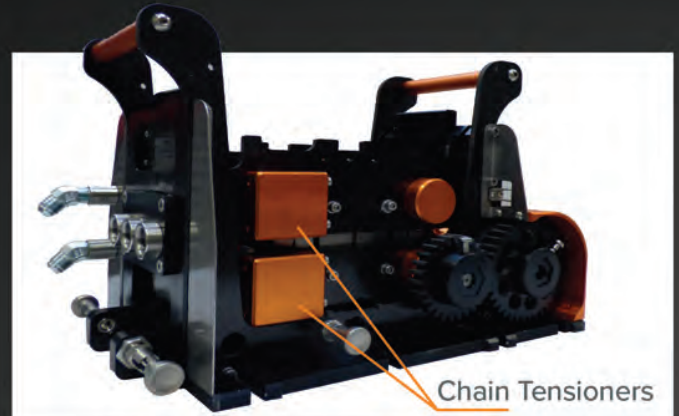

## AUTOMATIC CHAIN TENSIONER NEW

No more tensioning of chains.

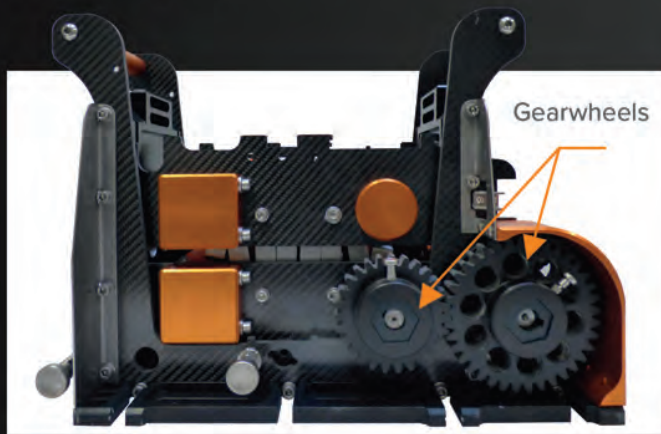

## POWER THROUGH GEARWHEELS NEW

Power transfer through gearwheels. Multiple configurations available for slower or faster speed.

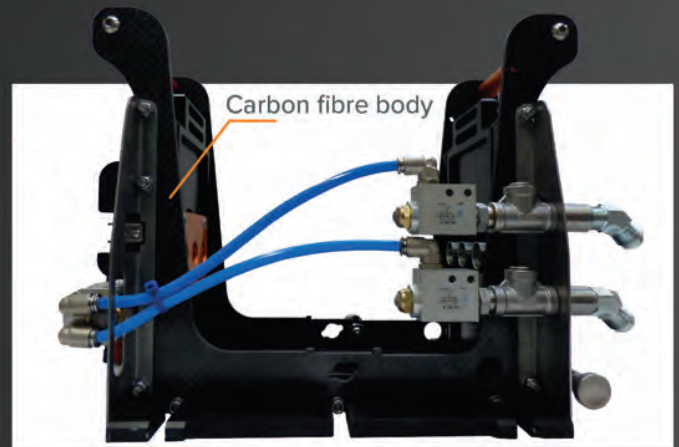

## EASY TO REMOVE CARTRIDGE NEW

Cartridges are easy to remove for cleaning and maintenance.



## CARTRIDGES NEW

Easy to exchange in the field without the use of any tools.

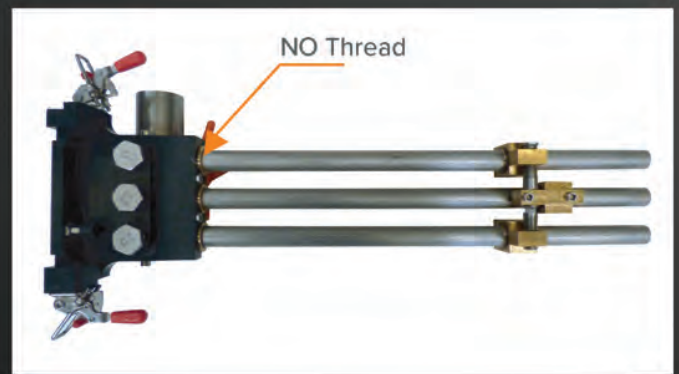

## GUIDE TUBE WITHOUT THREAD NEW

Quick changeable guide tube system without thread.

# TLX | FEATURES



## GEARWHEELS NEW

Power transfer through gearwheels. Multiple configurations available for slower or faster speed.



## PITCH ADJUSTER NEW

Pitch adjuster. Virtually no more tools required.



## HOSE CATCHER FOR PIPE CLEANING NEW

Spider Hose Catcher set keeps all sizes safely in one easy to use bundle.



## 10K OR 20K ROLODEX NEW

Hose catcher set keeps all sizes safety catchers in one easy to use bundle. sizes 4/2 - 8/2 and sizes 4/4 - 8/4

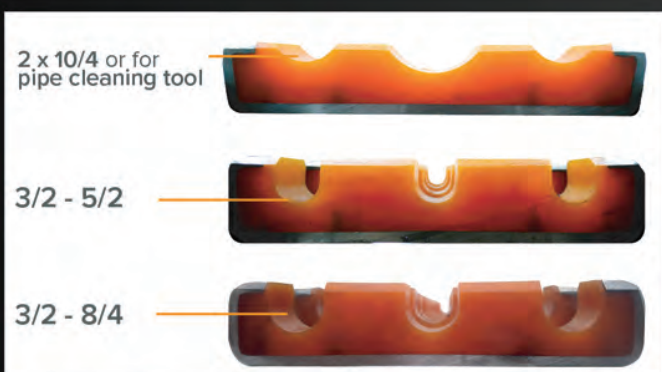

## TRACKS NEW

Two sizes of tracks for the dual or triple lance setup: 3/2 - 6/2 and 3/2 - 8/4  
Tracks for the pipe cleaning tool setup



## XY POSITIONER

With fixed legs. 210 x 221 x 99 cm, 83" x 87" x 39" OD



ATEX approved



# TLX | TYPICAL SETUP

## SOME FEATURES OF THE TLX:

Lightweight through the use of carbon fibre casing.  
Works with a cartridge for quick change of parts in the field.  
New Stainless Steel Track design resulting in minimal maintenance.  
Power transfer through gearwheels. Multiple configurations available for slower or faster speed.  
10K Rolodex and 20K Rolodex Hose Catcher sets keeps all sizes safety catchers in one easy to use bundle.  
Integrated handles for easy handling and safe lifting.  
Multifunctional: first 3 lance feeder that is convertible to a pipe cleaning tool.  
Accepts 3/2" to 8/4" hoses

Optional conversion for 2x10/4" or 2x3/8"  
Additional Pipe cleaning 3/8" - 3/4" hoses ( XXLTC )  
Quick changeable guide tube system without thread.  
Front mounted internally located airmotor, making the tool more compact.  
Can be fitted with 2nd motor for added strength when required.  
Optional flushing system.  
Automatic chain tensioners (never need adjustment).  
Friction can be controlled through friction springs or air cylinders.  
Virtually no tools required.



ATEX approved



TLX - VARIOUS SUITABLE APPLICATIONS



# TLX | NEW SCAFFOLD PIPE SETUP

Adjustable without air pressure

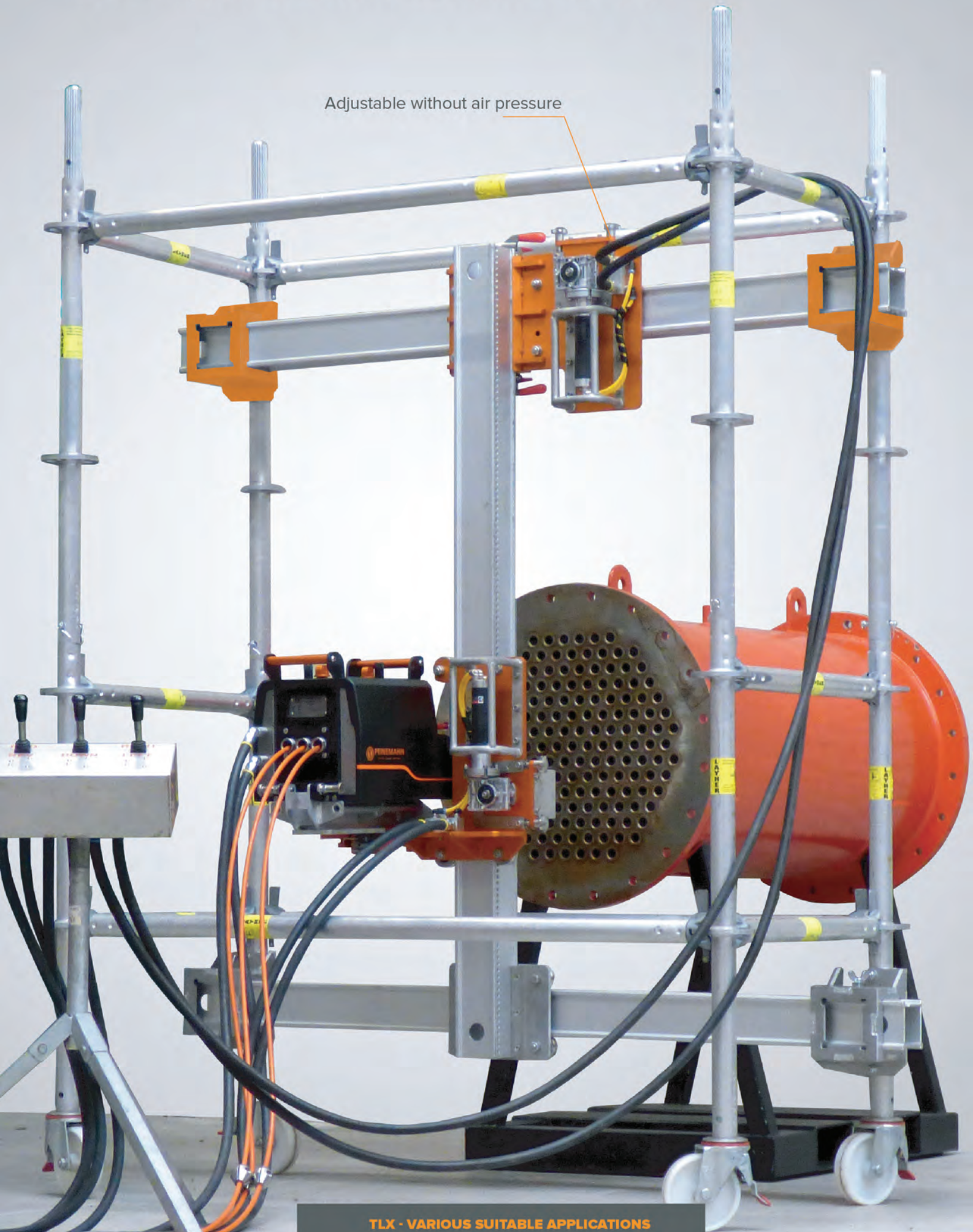

TLX - VARIOUS SUITABLE APPLICATIONS



# TLX | TYPICAL FIN FAN SETUP

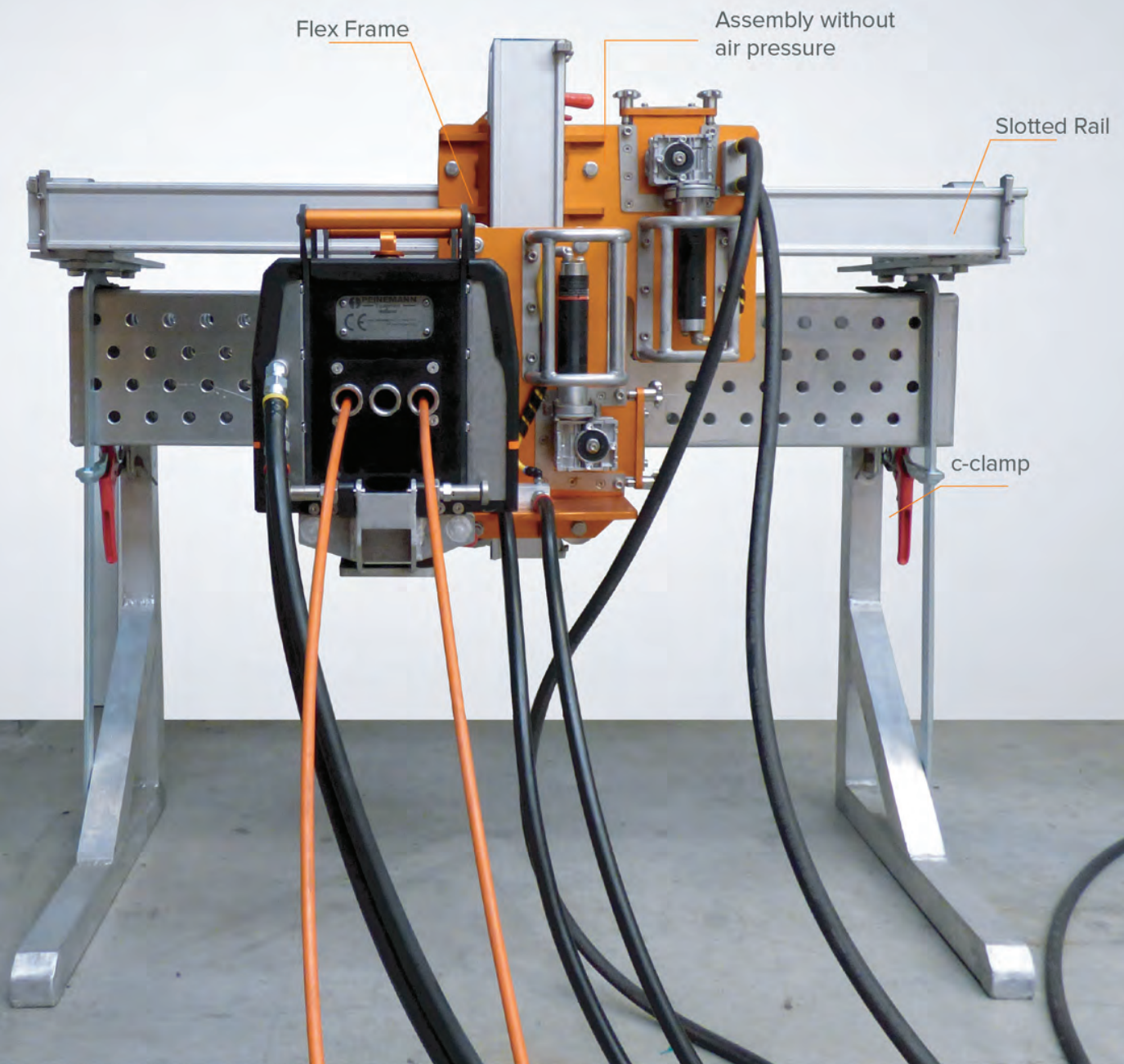

## MOUNTING BRACKET

One or two required depending on configuration.



## C-CLAMP

800 mm C-clamp with mounting bracket for box rail.



## SLOTTED RAIL/FLEX FRAME

Slotted rail for guiding the non driven cart.

# TLX | PIPE CLEANING TOOL SETUP

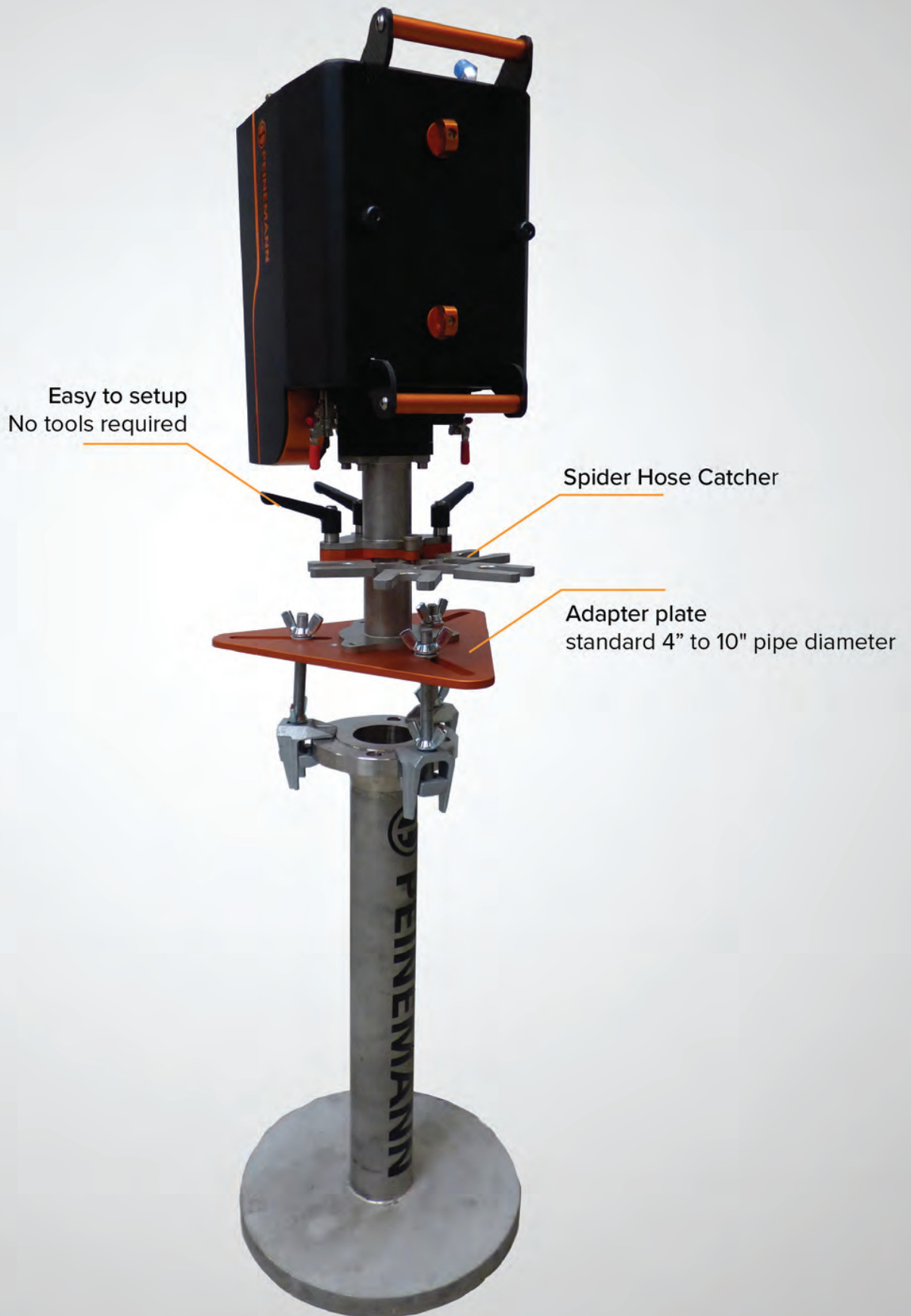

TLX - VARIOUS SUITABLE APPLICATIONS



# TLX | VERTICAL SETUP

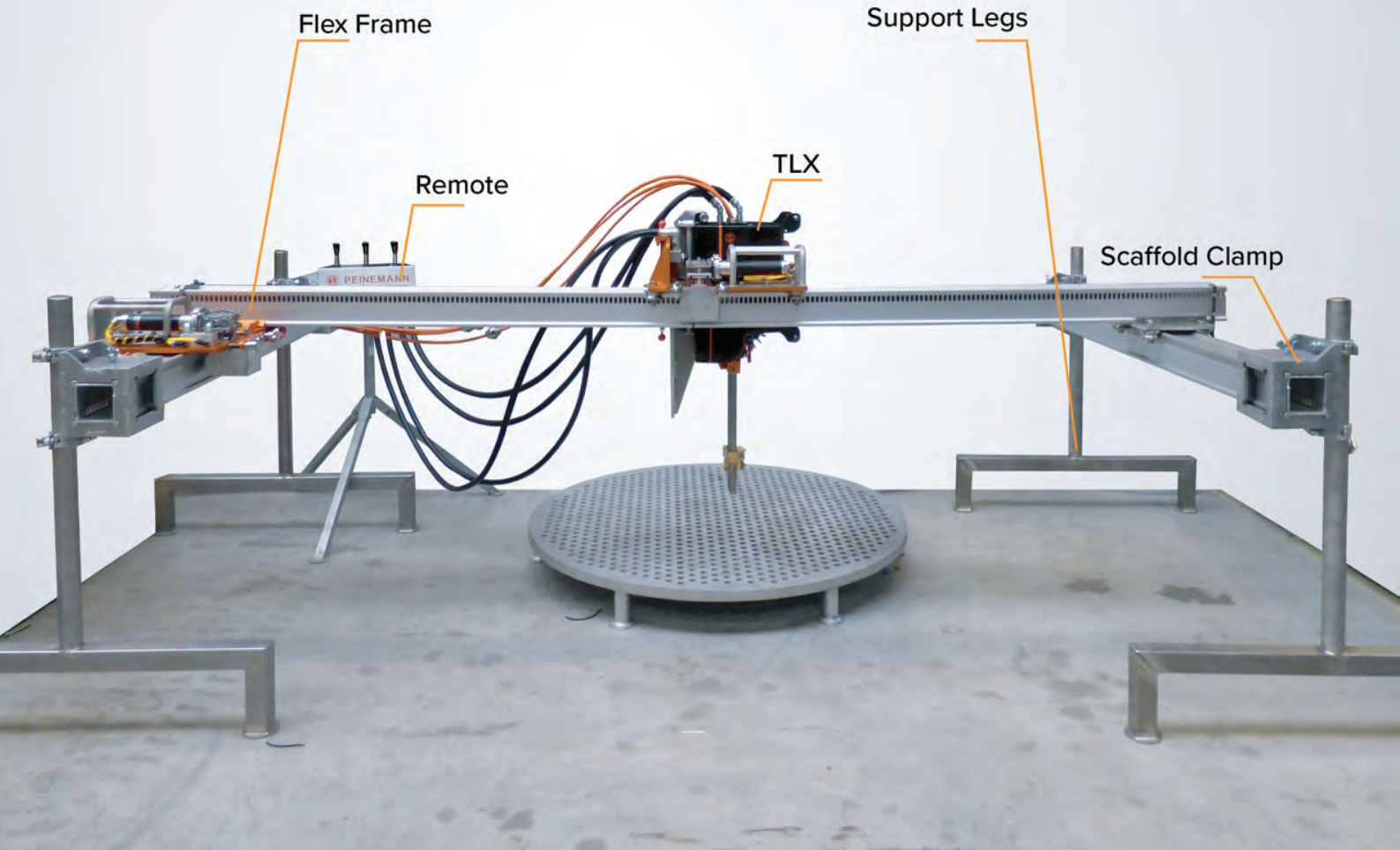

## MOUNTING BRACKET

One or two required depending on configuration.

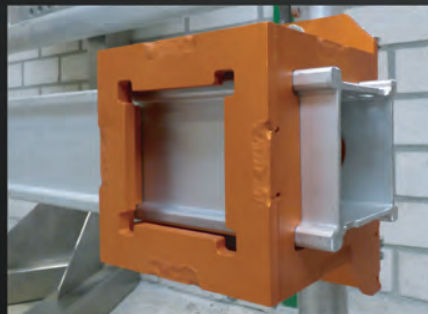

## SCAFFOLD CLAMP

For mounting a flex frame in vertical position on support legs.



## SLOTTED RAIL/FLEX FRAME

Slotted rail for guiding the non driven cart.



# TLX | ACCESSORIES



## MOUNTING CLAMPS XL NEW

Stainless steel mounting clamps



## MOUNTING CLAMPS XL NEW

Stainless steel mounting clamps.



## BEND GUIDE TUBE

For mounting on a Flex Frame (Flex Frame not included).

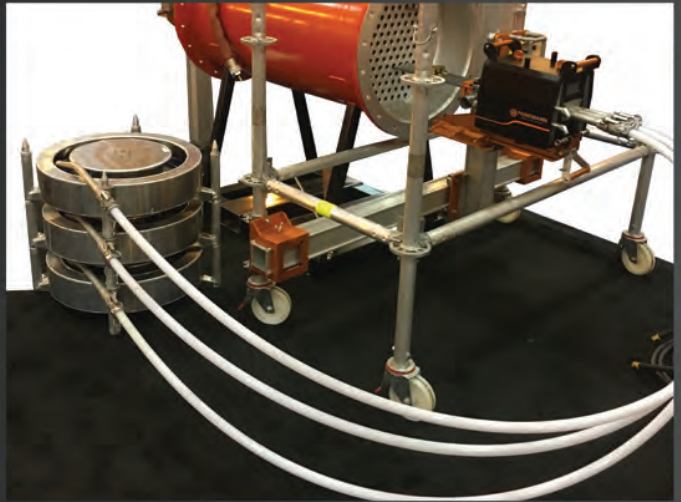

## HOSE REEL

Individual stackable hose reel. 1400 bar for hose size 3/2 - 8/4.



## FINFAN ADAPTER

Snorkle hoses with adapter for 3XLTC or TLX. For use in tight spaces with adjustable pitch.

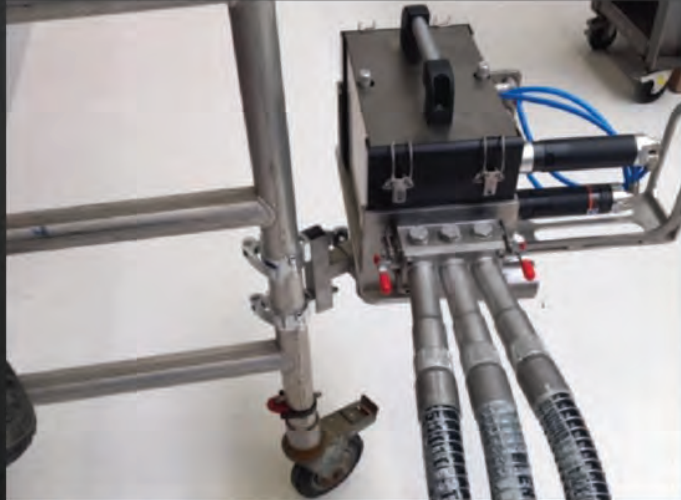

## SCAFFOLD ATTACHMENT

Adapter for 3XLTC or TLX to attach to scaffolding.



# TLX | ACCESSORIES



ATEX approved

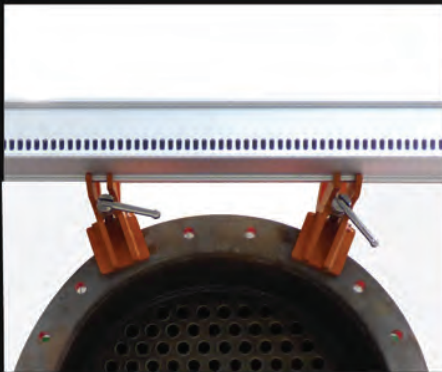

## CLAMPS NEW

Flange clamps for mounting a Flex Frame setup on an exchanger. No tools required for attaching the clamps to the exchanger.

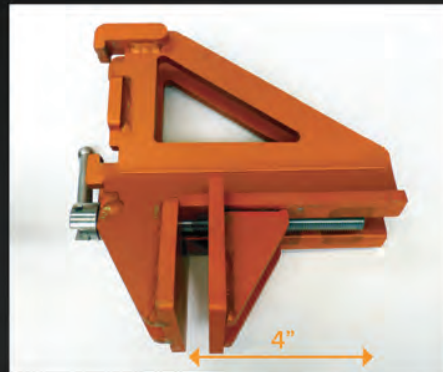

## CLAMPS NEW

Weight: 3kg / 6.6 Lbs.  
10cm / 4" spread



## SCAFFOLD CLAMP NEW

For mounting a Flex Frame on a scaffold pipe or support leg.



## MOUNTING BRACKETS

For mounting on a Flex Frame (Flex Frame not included).



## SLOTTED RAIL NEW

Slotted rail with holes to connect two pieces together.



## CONNECTOR SLOTTED RAIL

Connector for connecting multiple slotted rails.



## SUPPORT LEGS

For mounting a Flex Frame in vertical position (Flex Frame not included).



## TIMERBOX NEW

Pneumatic Timerbox which can be attached to standard remote controls to create an automatic forward reverse stroke.



## NON DRIVEN CART

For additional support of Flex Frame on opposite side.





# PEINEMANN

RENTAL - SALES - SERVICES

**PEINEMANN EQUIPMENT B.V.**

MANDENMAKERSTRAAT 190  
3194 DG HOOGVLIET  
THE NETHERLANDS  
T: +31(0)10 - 29 55 000

**PEINEMANN EQUIPMENT U.S.A, INC.**

25702 ALDINE WESTFIELD  
BUILDING 1002  
SPRING, TX 77373, U.S.A.  
T: +1 281 288 7979

**E: [EQUIPMENT@PEINEMANN.NL](mailto:EQUIPMENT@PEINEMANN.NL) [WWW.PEINEMANNEQUIPMENT.COM](http://WWW.PEINEMANNEQUIPMENT.COM)**